

**Reference documents:**

Technical approval:  
 PZH-NIH Hygienic Certificate:  
 Declaration of Performance:

**ETA-15/0511**  
**HK/B/0227/01/2014**  
**CARBO/008 17-10-2016**

**Technical data:**

<b>Fire resistance class</b>	max. EI 120
<b>Colour</b>	dark graphite
<b>Environmental class</b>	Z1, Z2
<b>Storage temperature range</b>	+5°C to +35°C
<b>Shelf life</b>	Unlimited; however, best before 24 months.
<b>Commercial packaging</b>	30 m roll
<b>Flat size (thickness × width)</b>	(2.5; 4.0) × 60 mm (3.0; 4.8) × 100 mm

**Product description:**

MULTITUBE is a band in the form of tape on a drum. Unwound and trimmed to length, the band forms an intumescent fire-proof wrap. MULTITUBE is a mixture of polymers and fillers that cause the applied band to swell when exposed to fire.

**Intended use:**

MULTITUBE is intended for building fire-proof seals of installation partitions in walls and floors with flammable piping and non-flammable piping insulated with flammable synthetic thermo insulating foam, e.g. Kaflex or Armaflex. The product can be used to seal the penetrations of cable bundles in walls and floors.

**Application:**

Wrap the outer tube or thermo insulating foam with MULTITUBE along the circumference. The number of wraps and the total thickness of the band is specified in ETA 15/0511. Wrap the strips of MULTITUBE around one another until the required thickness is achieved. MULTITUBE can be wrapped in one or two rows directly next to each other. Once wound around the pipe to the required thickness, slide the band into the penetration opening: place it exactly in the middle of the wall thickness; when installed in a floor penetration, place it approx. 10 to 15 mm over the bottom floor surface. Secure the MULTITUBE wrap in place with a zip tie. Fill the penetration flush with cement mortar. Once applied, mark the penetration with the tag supplied with the MULTITUBE roll.

**Health and safety:**

This product is intended for professional use in an industrial environment. Follow the applicable health, safety and environmental protection regulations when using and applying the product. Read the MSDS of the product before use.

Calculating the MULTITUBE wrap strip length per number of winds

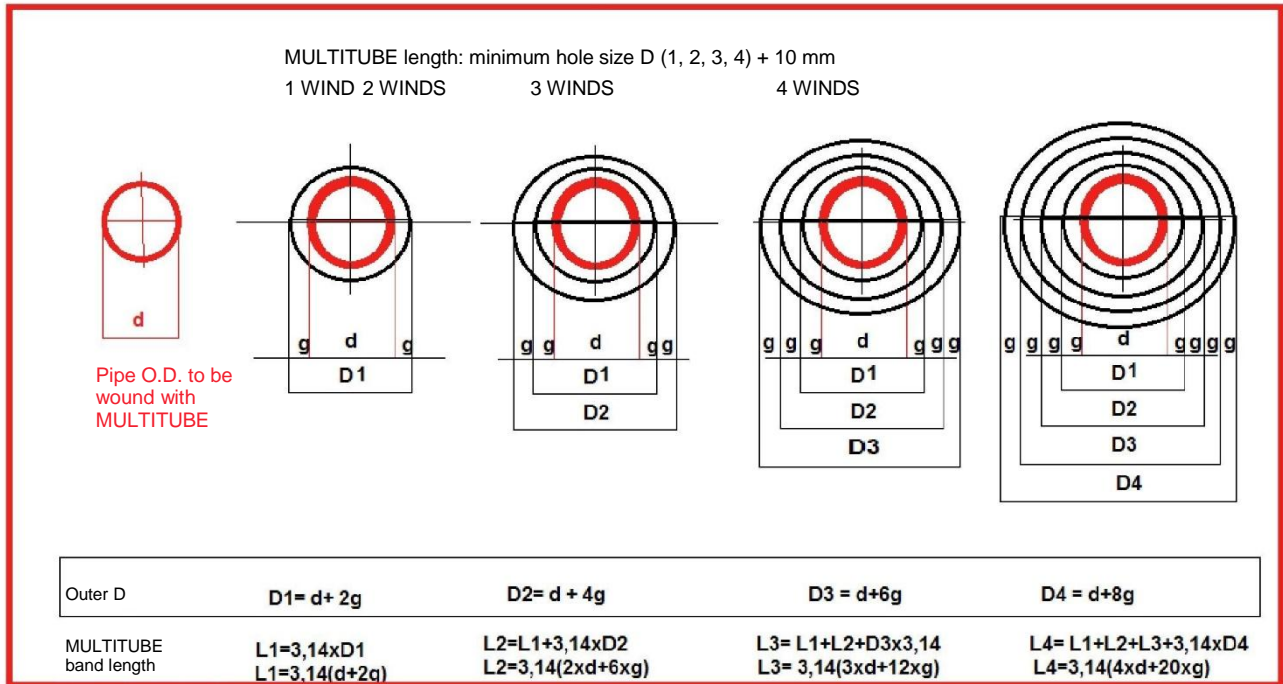

Version 08.2017 supersedes Version 09.2015.

The information provided herein is based on the knowledge and experience of the manufacturer on the date of issue hereof. All information is provided in good will. Given the variety of application methods and conditions, verify them in actual conditions. The manufacturer declines all liability not related to the conditions in the valid standard.